

# Übersicht Bogen 1

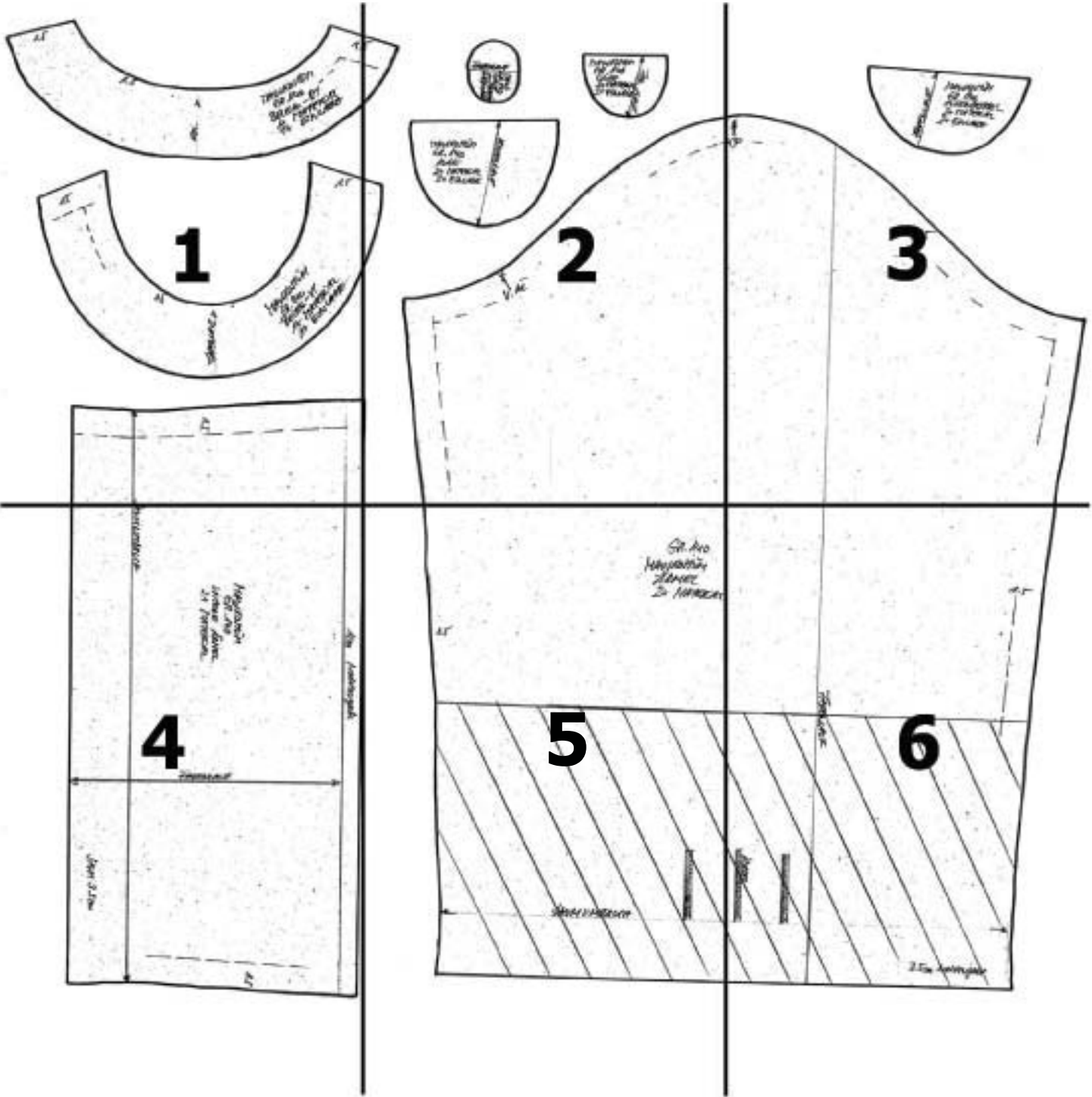

# Übersicht Bogen 2

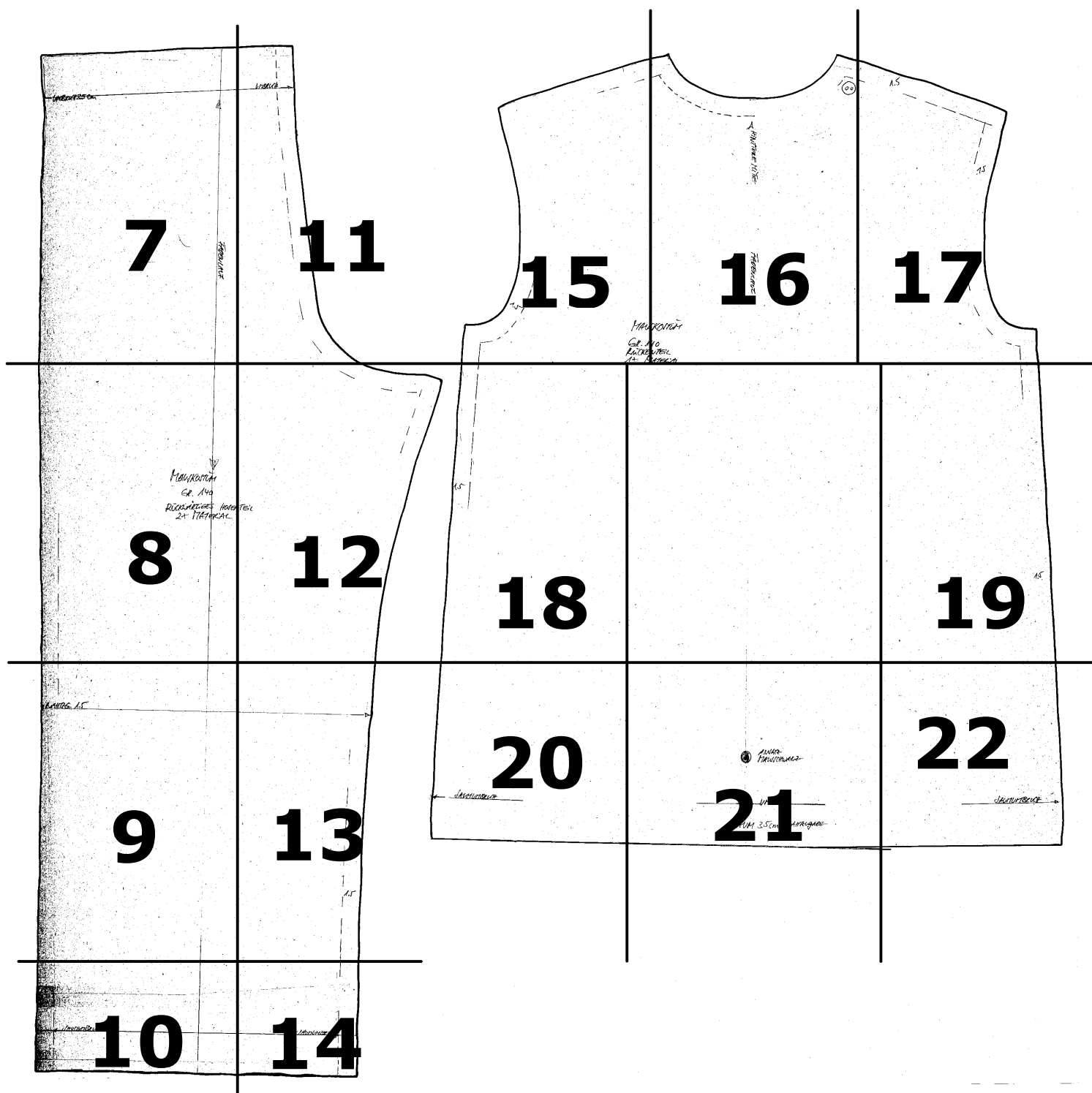

# Übersicht Bogen 3

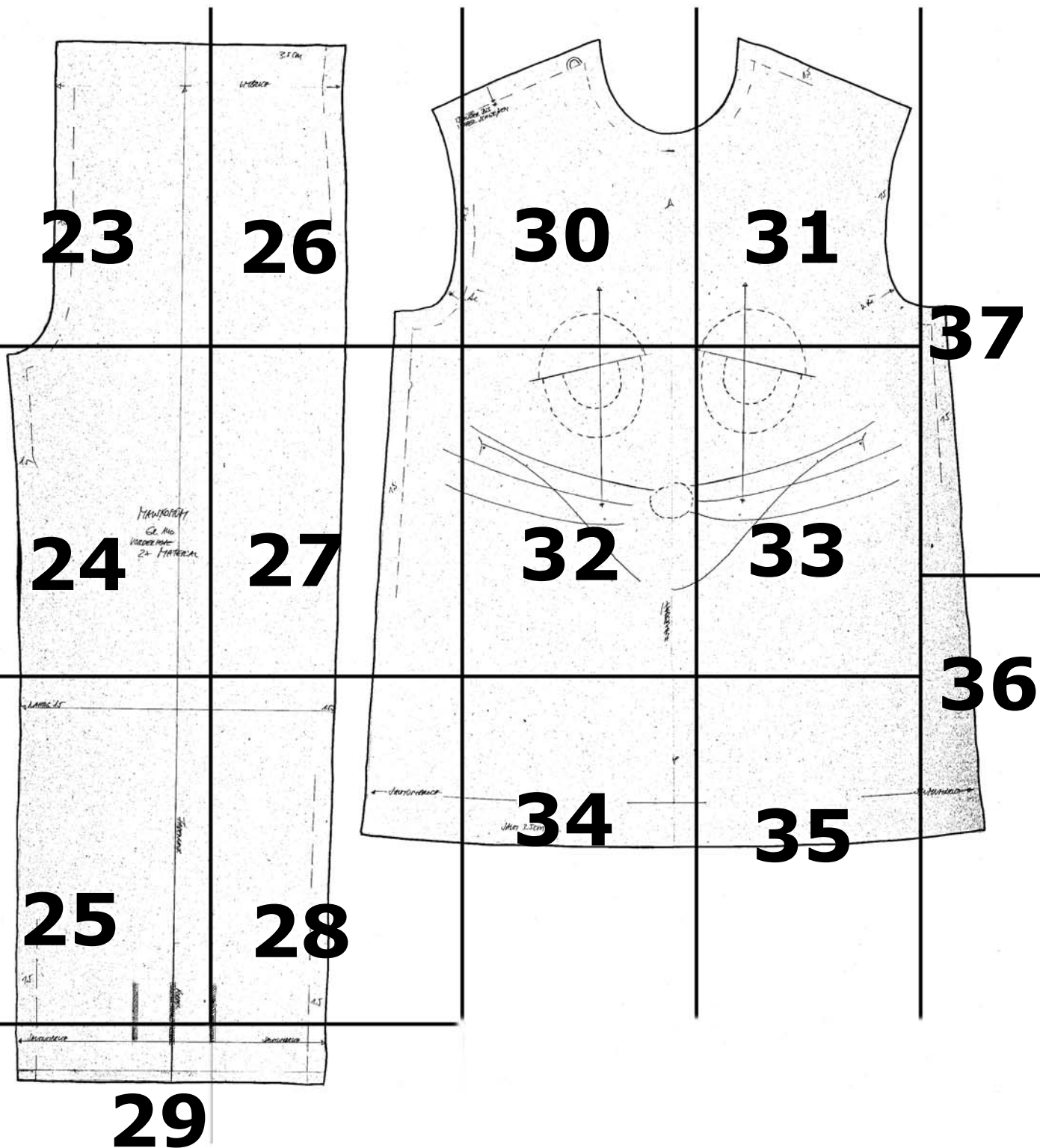

1

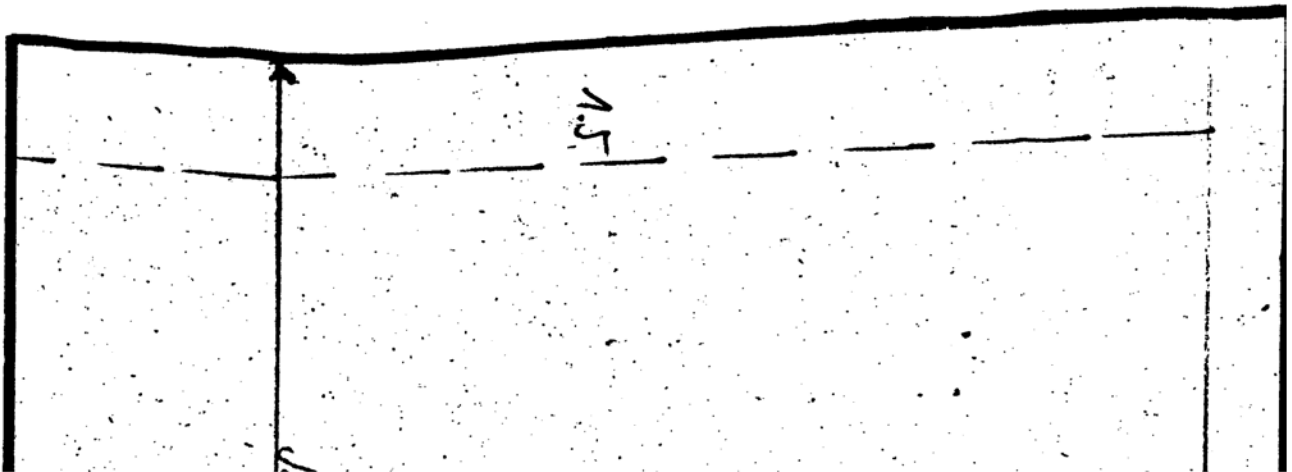
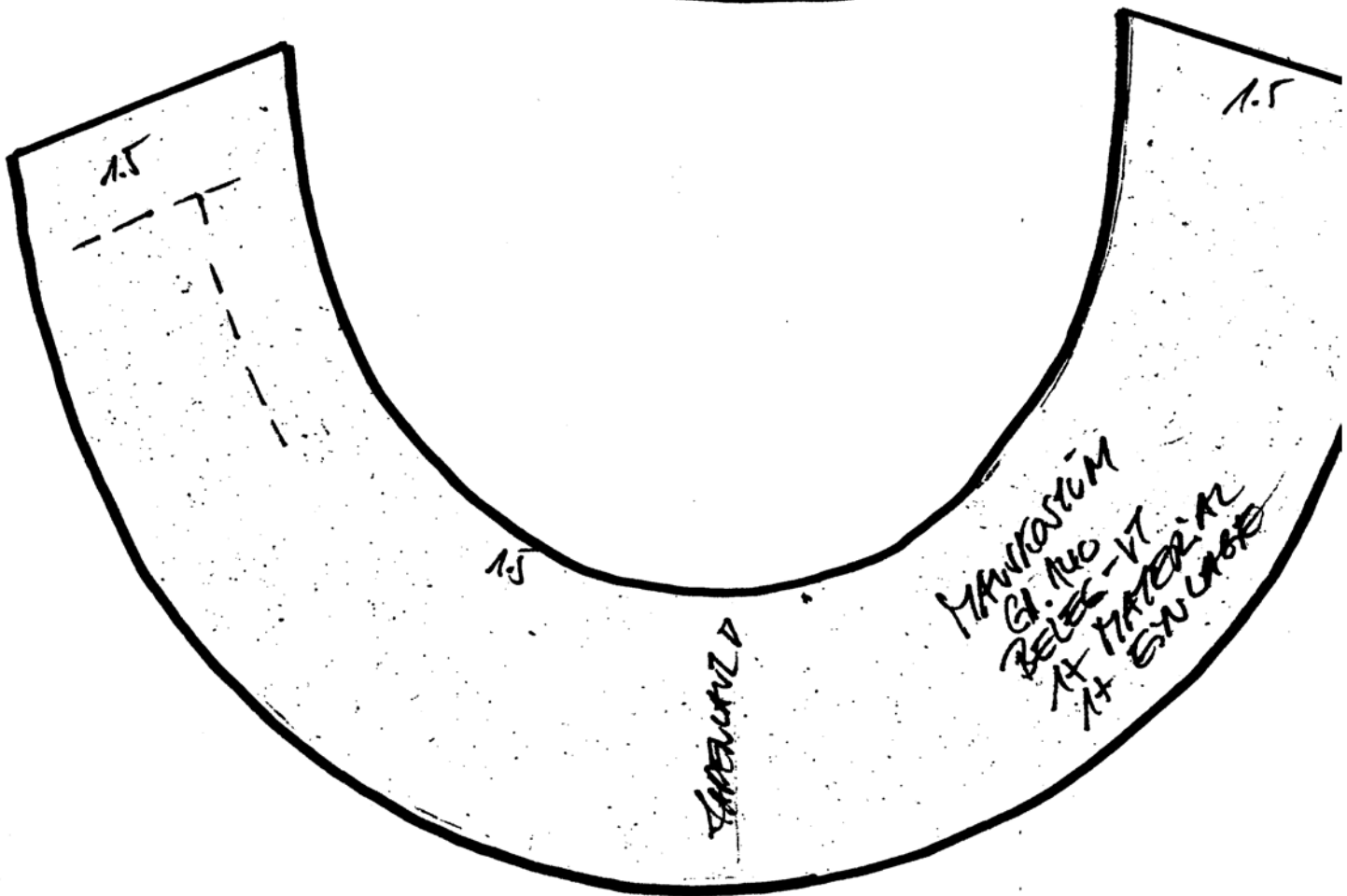
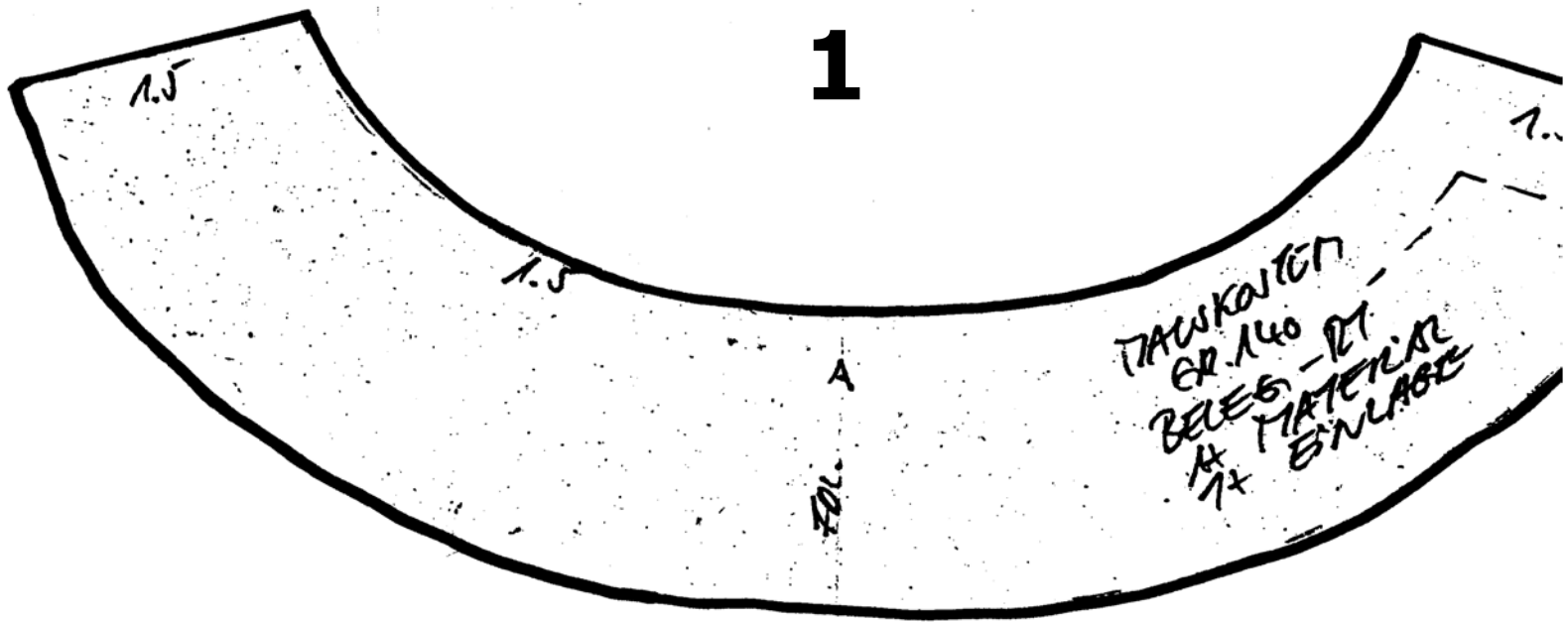

2

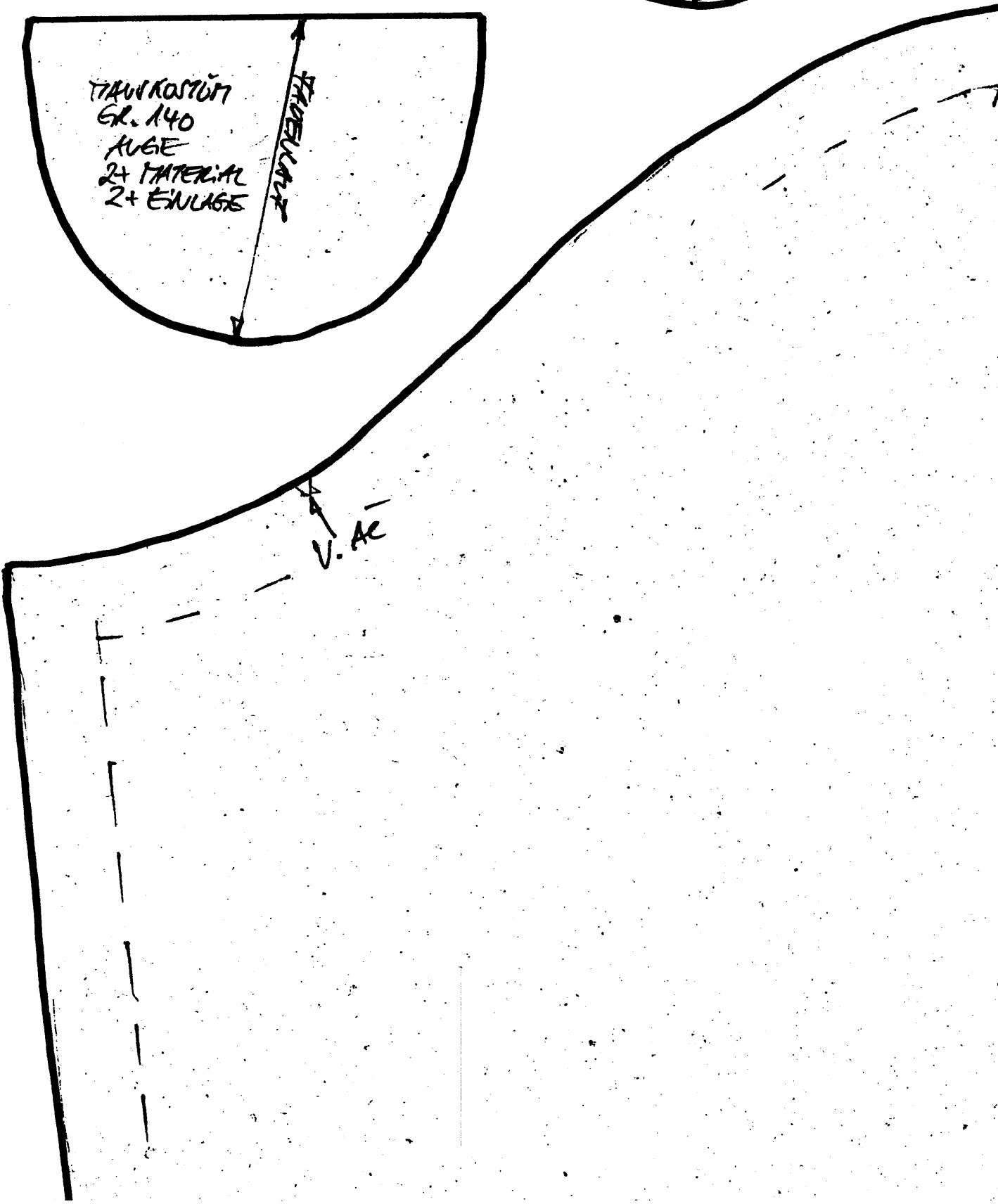
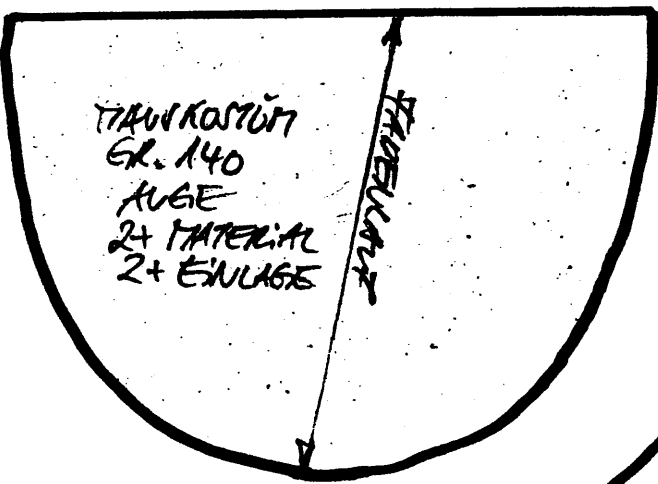
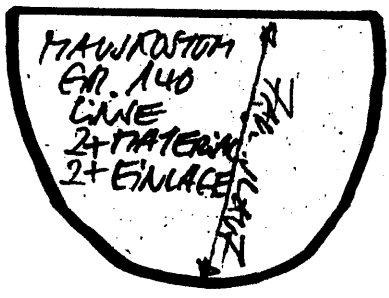
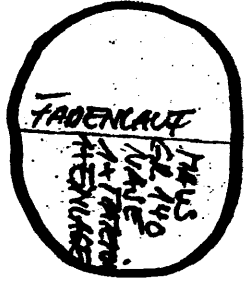

3

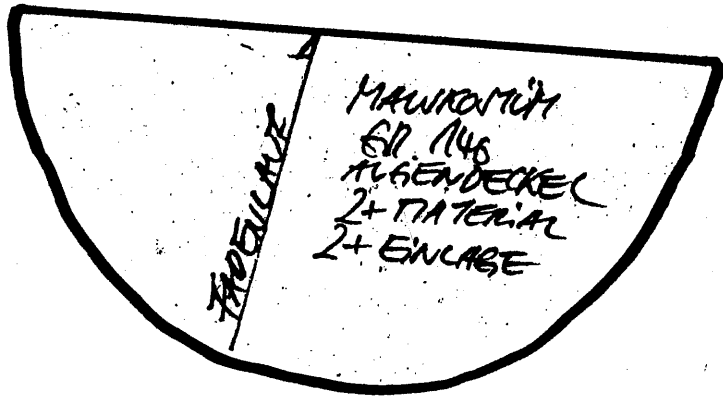

KP —

1.5

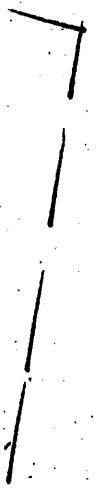

1cm Nalotzoggel

MAUKAMIN  
GR. 140  
WASSE KUNST  
2+ MATERIAL

FADENMAUT

SKIN 3.5cm

1.5

WILDBUCH

Gr. 140  
MANIKOTTUM  
ÄRMEL  
2x MATERIAL

1.5

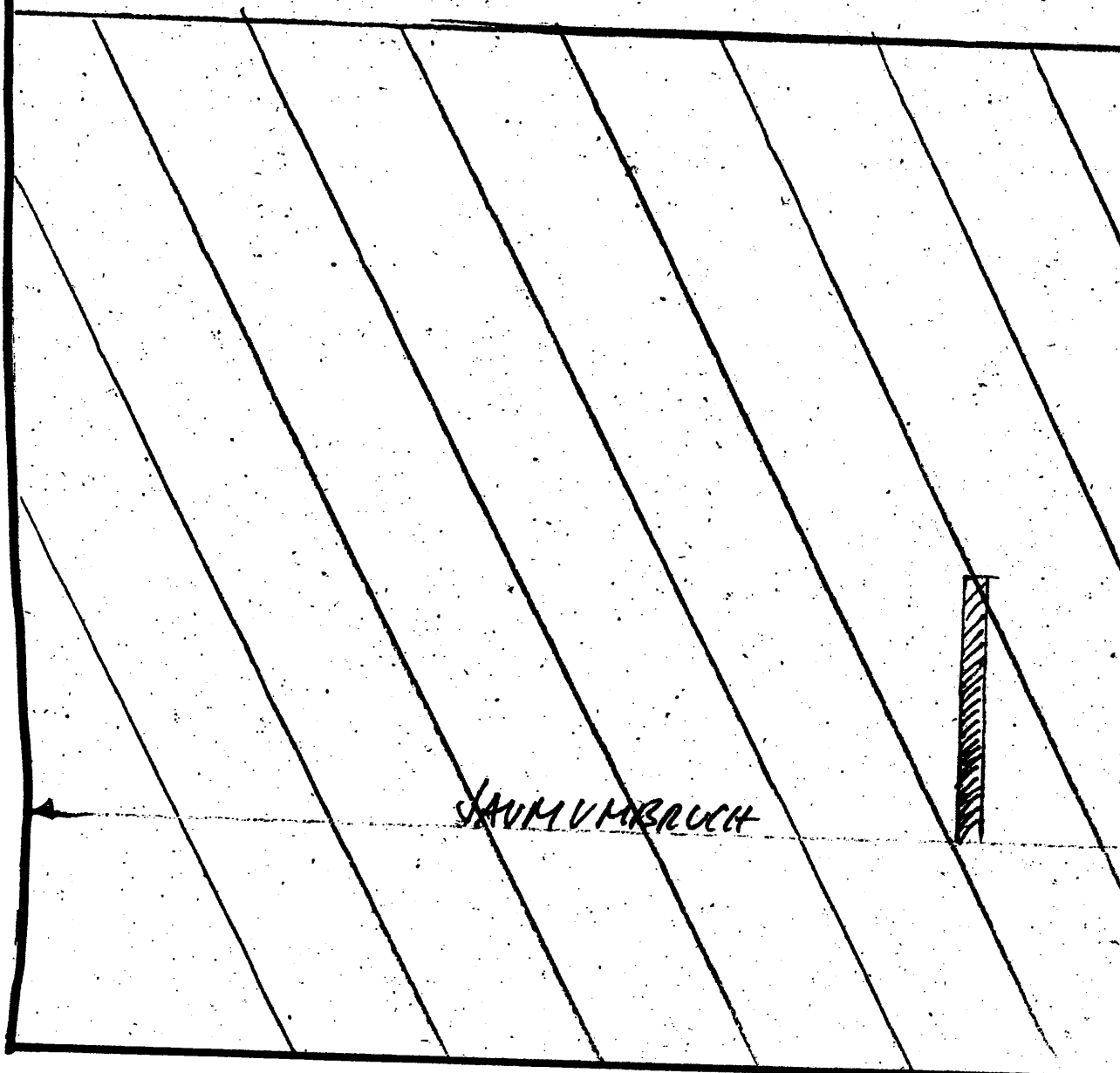

SAUMVERBRUCH



6

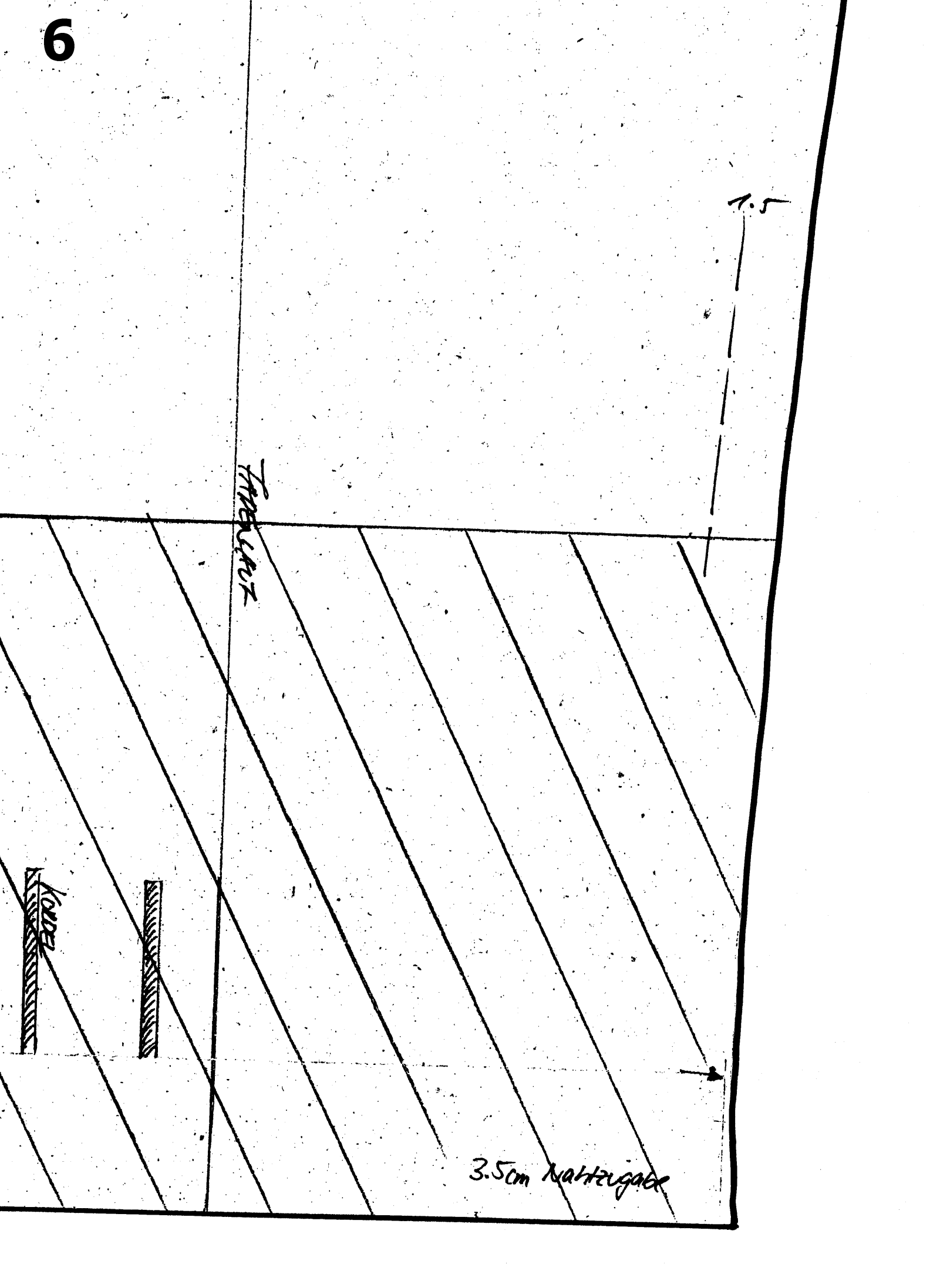

Trennlinie

1.5

3.5cm Nutzugab

Körper

SECRET 350

7

FROBENIUS

8

  
MAWKOSTUM

GR. 140

RÜCKWÄRTIGES HOSEN  
2x MATERIAL

NAH26. 1.5

9

	1407073244	

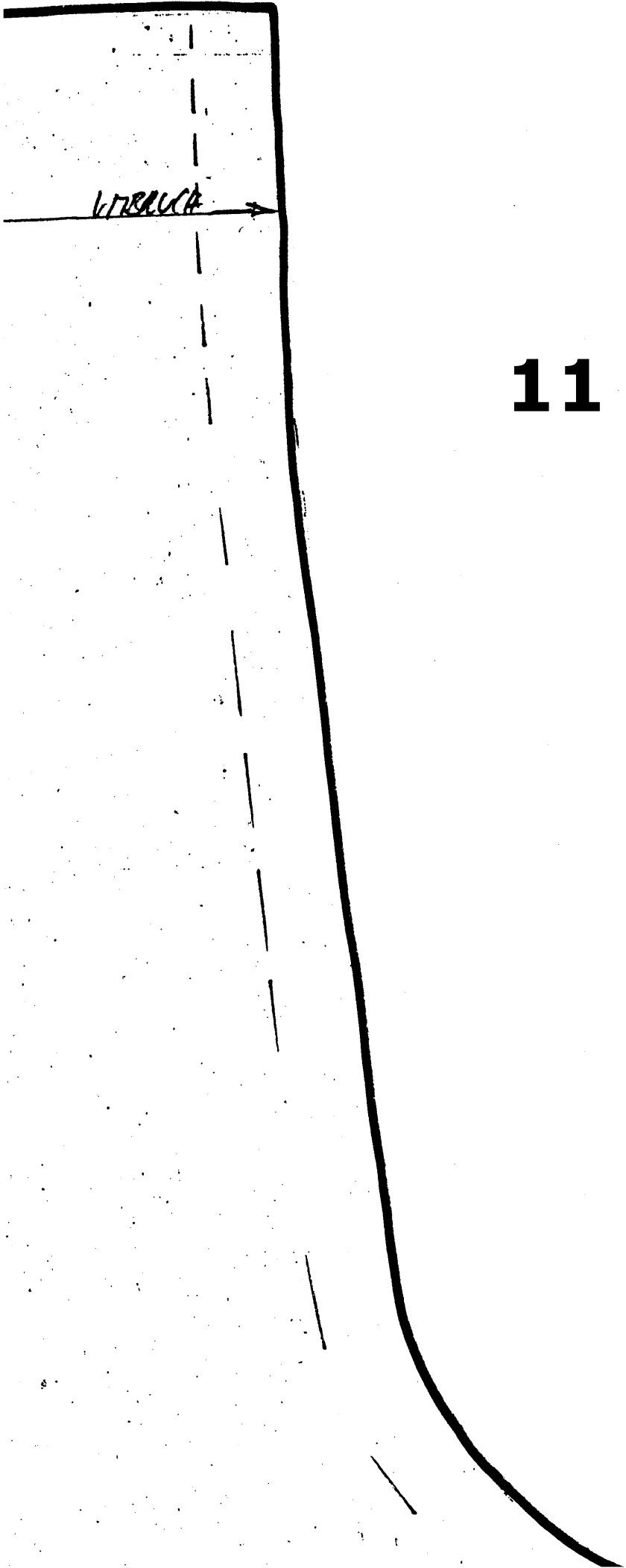

**11**

**12**

ITSL

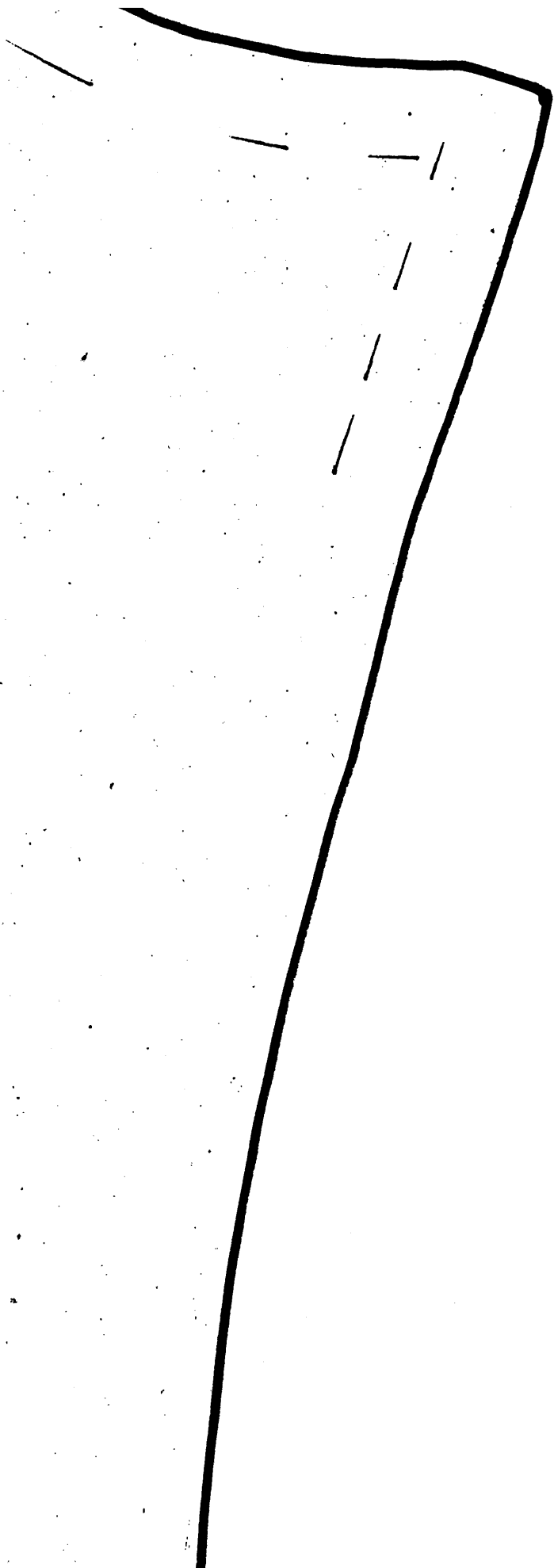

**13**

1.5



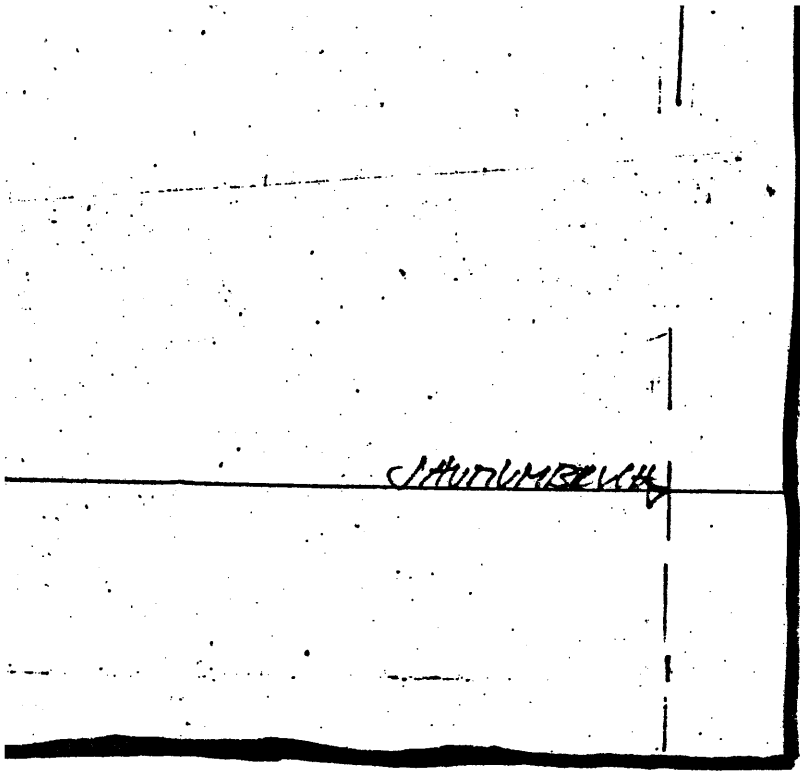

15

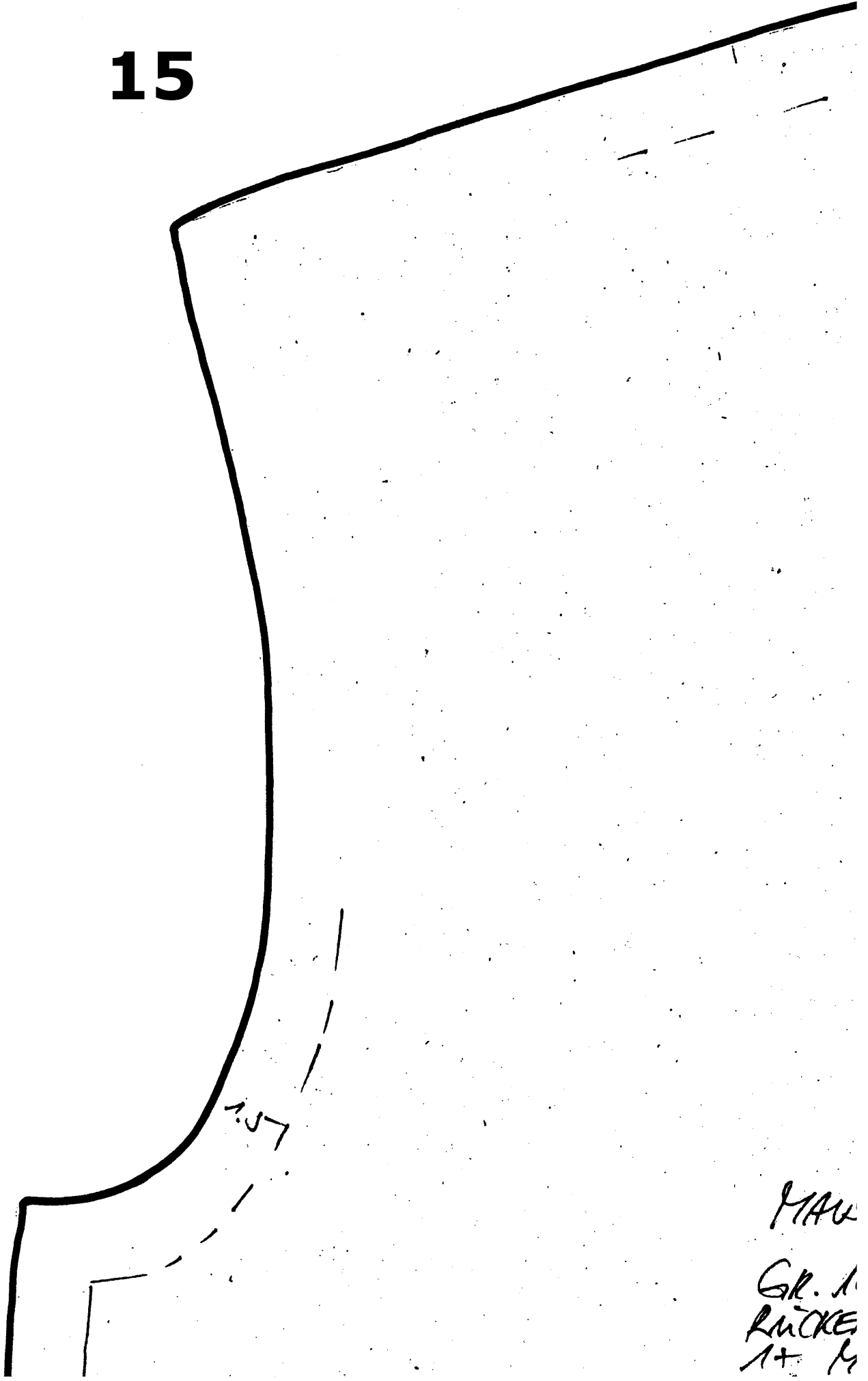

MAU  
Gr. 1  
RUCKE  
A+ M

16



A HINTERE NÄHE

FÄRBEREICH

SKONTUM

40  
NTEIL  
MATERIAL

17

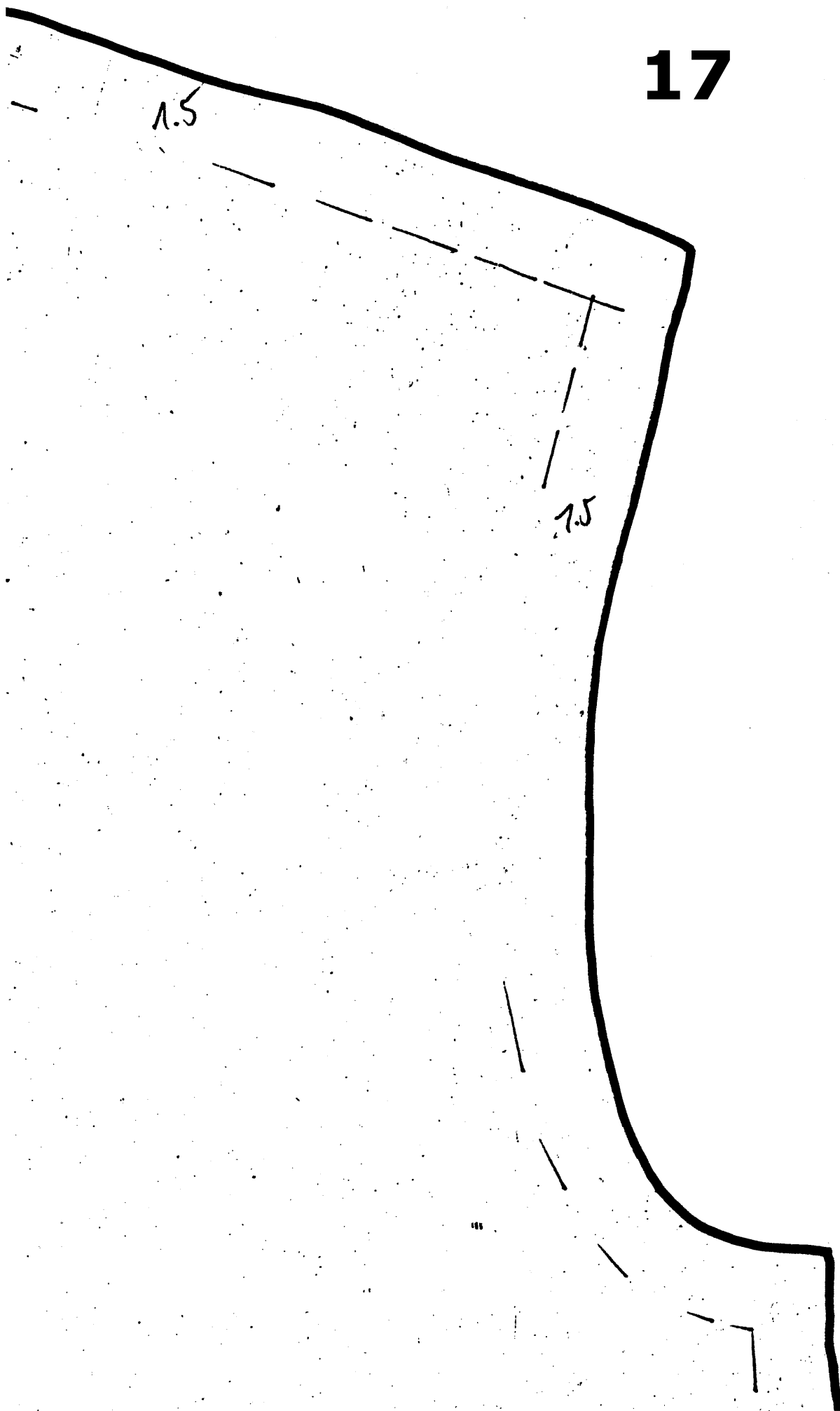

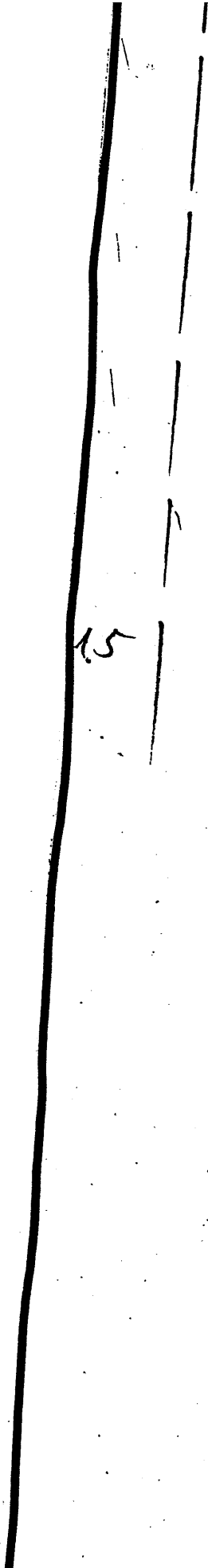

**18**

**19**

1.5

SAUMMIBUCH



ANWAZ  
KRAUSCHWANZ

---

UMBRUCH

SAUM 3.5cm NAHRGABE



JAUMUMBUCK →

23

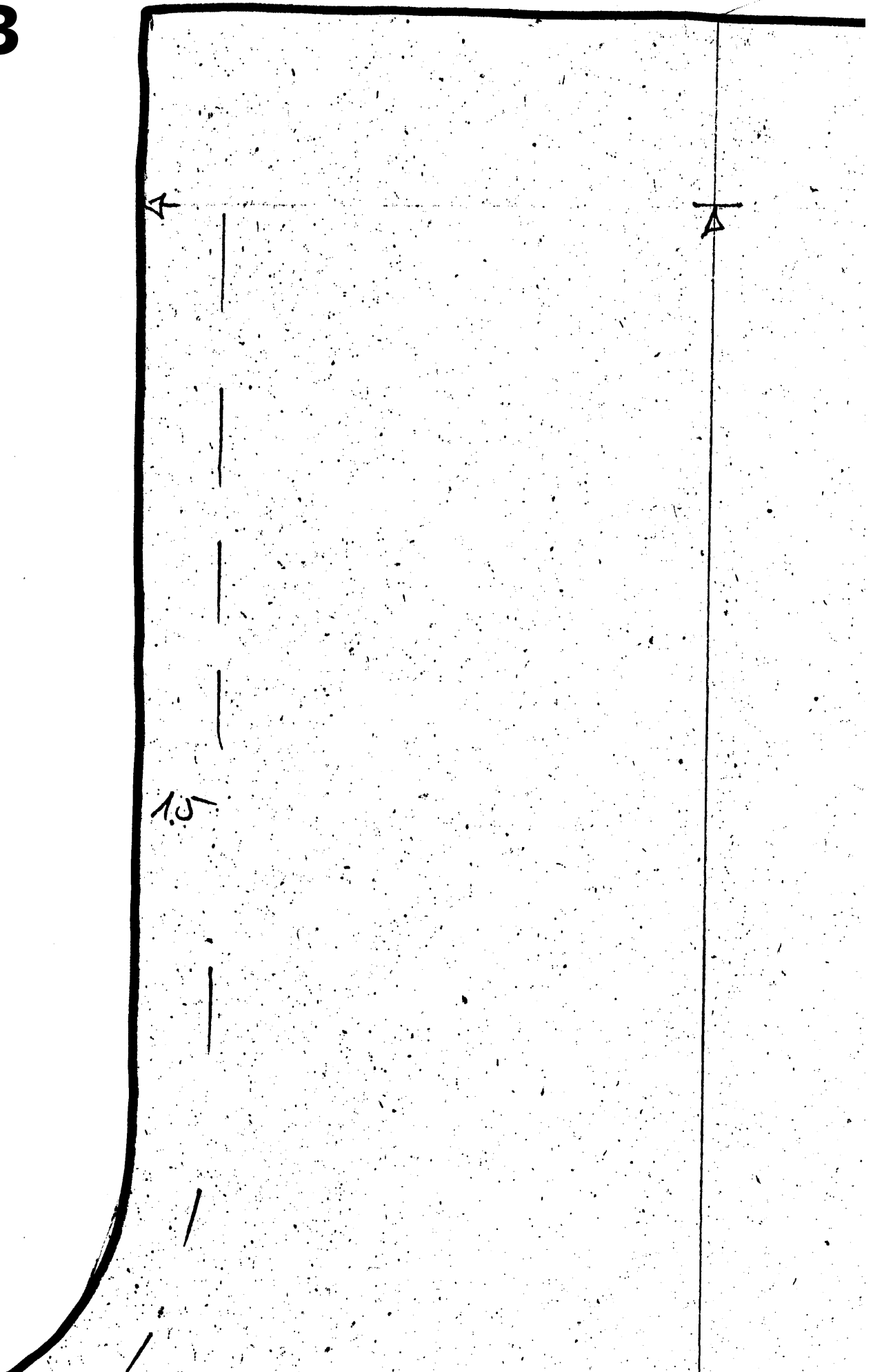

24

1.5

MAWKOSTUM

Gr. 140

VORDERHOSE

2x MATERIAL

→ 11/17/26. 15

25

THORNTON

75



3.5 cm

1.5 cm



26

13 cm  
17 cm

1.5 cm

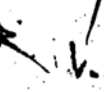

**27**

75

1.5

→ ЖУТОМ БРОК

28

1.5



29



30

BRÄUTER BIS \*  
PFEIL SCHWEPEN

1.5

v. Ac



A

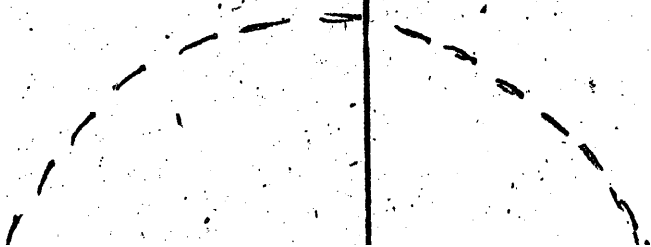

31



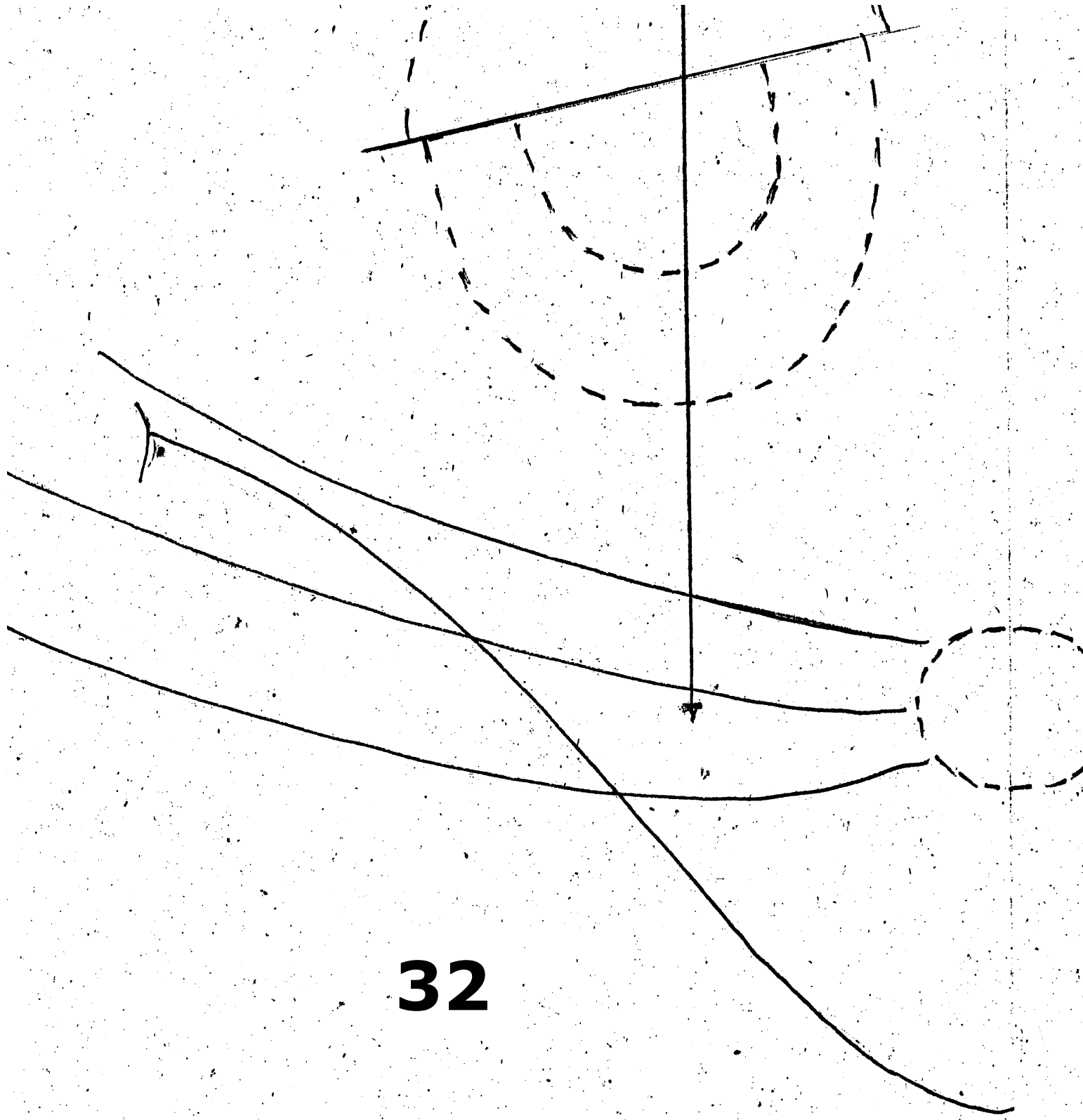

**32**

*PROPELLER*

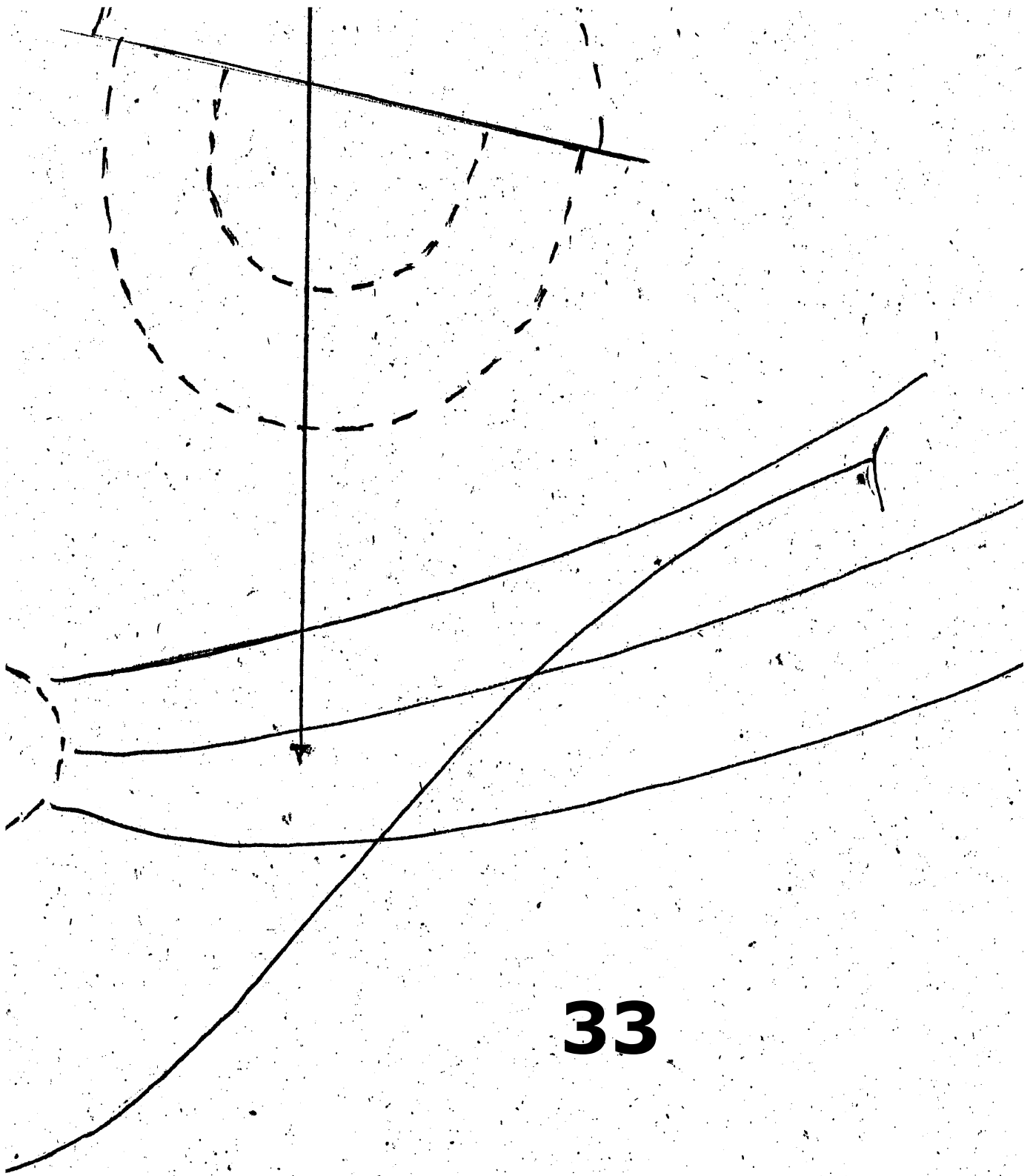

**33**

**34**

JAUM 3.5cm

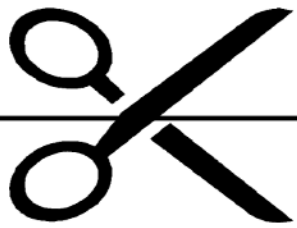

**35**

SA

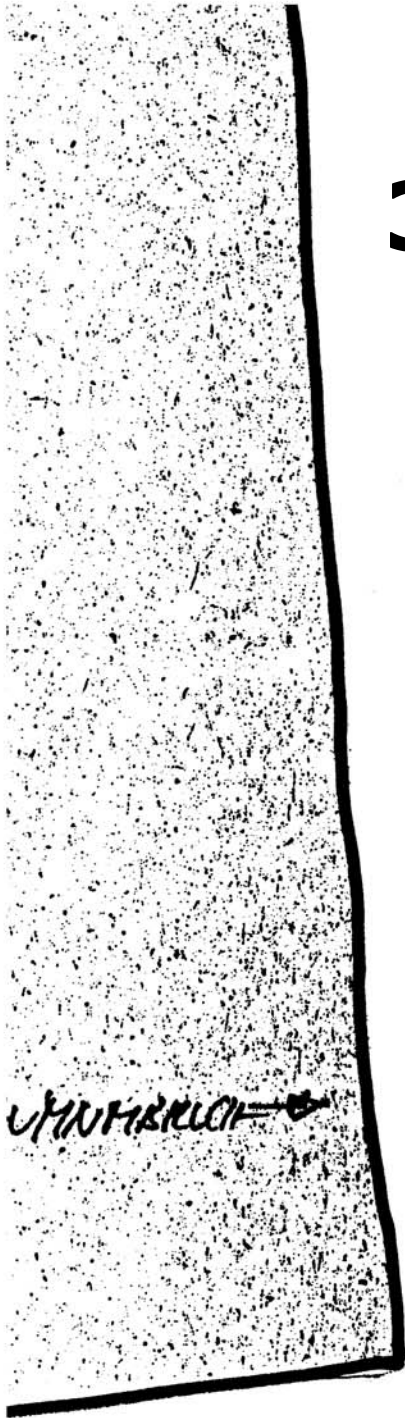

**36**

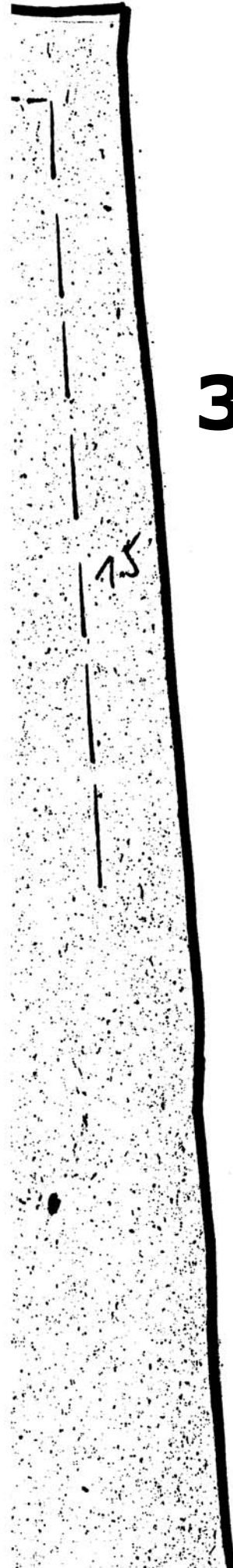

**37**

